

GREISINGER electronic GmbH**Transmitter for****humidity****with option: selectable humidity display**

from version V3.2

Operating Manual

GRHU ... MP / UNI**Content**

1	INTENDED USE	2
2	GENERAL ADVICE	2
3	SAFETY INSTRUCTIONS	2
4	DISPOSAL NOTES	2
5	ASSIGNMENT OF ELBOW-TYPE PLUG (DEPENDING ON TYPE)	3
6	GENERAL INSTALLATION INSTRUCTIONS:	3
7	DESIGN TYPES, DIMENSION	3
8	DISPLAY FUNCTIONS	4
8.1	MEASURING DISPLAY	4
8.2	MIN/MAX VALUE MEMORY	4
8.3	USAGE OF UNIT-LABELS	4
9	ERROR AND SYSTEM MESSAGES	4
10	CONFIGURATION OF THE DEVICE	5
11	NOTES TO THE CALIBRATION SERVICES	5
12	SPECIFICATION	6



WEEE-Reg.-Nr.: DE93889386

**GREISINGER electronic GmbH****D - 93128 Regenstauf, Hans-Sachs-Straße 26**☎ +49 (0) 9402 / 9383-0 📠 +49 (0) 9402 / 9383-33 📧 info@greisinger.de

1 Intended use

The device measures the relative humidity and temperature of air or non corrosive / non ionizing gases. From this values others can be derived and displayed instead of the rel. humidity.

Field of application

- Room climate monitoring
 - Monitoring of storage rooms
- etc...

The safety instructions (see chapter 3) have to be observed.

The device must not be used for purposes and under conditions for that the device had not been designed. The device must carefully dealt with and has to be used according to the specifications (do not throw, knock, etc.). It has to be protected against dirt.

Do not expose the sensor to aggressive gases (like ammonia) for longer time.

Avoid condensation, as after drying there may remain residues, which may affect the precision negatively.

In dusty environment additional protection has to be applied (special protection caps).

2 General advice

Read through this document attentively and make yourself familiar to the operation of the device before you use it. Keep this document in a ready-to-hand way in order to be able to look up in the case of doubt.

3 Safety instructions

This device has been designed and tested in accordance to the safety regulations for electronic devices. However, its trouble-free operation and reliability cannot be guaranteed unless the standard safety measures and special safety advises given in this manual will be adhered to when using it.

1. Trouble-free operation and reliability of the device can only be guaranteed if it is not subjected to any other climatic conditions than those stated under "Specification".
Transporting the device from a cold to a warm environment condensation may result in a failure of the function. In such a case make sure the device temperature has adjusted to the ambient temperature before trying a new start-up.
2. General instructions and safety regulations for electric, light and heavy current plants, including domestic safety regulations (e.g. VDE), have to be observed.
3. If device is to be connected to other devices (e.g. via PC) the circuitry has to be designed most carefully. Internal connection in third party devices (e.g. connection GND and earth) may result in not-permissible voltages impairing or destroying the device or another device connected.
4. Whenever there may be a risk whatsoever involved in running it, the device has to be switched off immediately and to be marked accordingly to avoid re-starting. Operator safety may be a risk if:
 - there is visible damage to the device
 - the device is not working as specified
 - the device has been stored under unsuitable conditions for a longer timeIn case of doubt, please return device to manufacturer for repair or maintenance.
5. **Warning:** Do not use this product as safety or emergency stop device or in any other application where failure of the product could result in personal injury or material damage.
Failure to comply with these instructions could result in death or serious injury and material damage.

4 Disposal notes



This device must not be disposed as "residual waste".

To dispose this device, please send it directly to us (adequately stamped).

We will dispose it appropriately and environmentally friendly.

5 Assignment of elbow-type plug (depending on type)

4-20mA (2-wire connection)

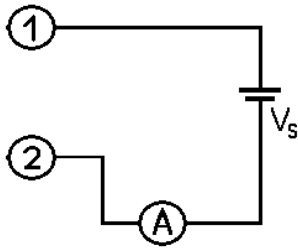

- 1 = supply voltage +Uv
- 2 = GND / signal

voltage (3-wire connection)

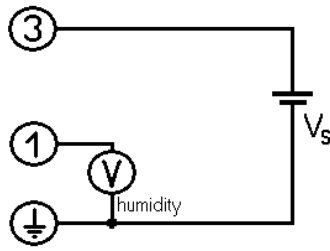

- 1 = signal +
- 3 = supply voltage +Uv
- ⊥ (4) = supply voltage -Uv
signal -

voltage (4-wire connection)

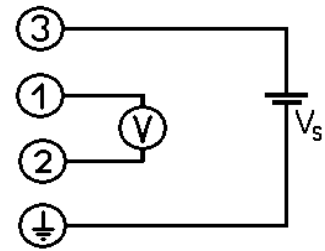

- 1 = signal +
- 2 = signal -
- 3 = supply voltage +Uv
- ⊥ (4) = supply voltage -Uv

The type "current-" or "voltage output" is set by works and cannot be changed.

6 General installation instructions:

To mount the connection cable (2-, 3-, or 4-wire depending on type of device) the elbow-type plug screw has to be loosened and the coupling insert has to be removed by means of a screw driver at the position indicated (arrow).

Pull out connection cable through PG gland and connect to the loose coupling insert as described in the wiring diagram. Replace loose coupling insert onto the pins at the transducer housing and turn cover cap with PG gland in the direction desired till it snaps on (4 different starting positions at 90° intervals). Re-tighten the screw at the angle plug.

7 Design types, dimension

GRHU-1R-MP
short sensor tube aside



GRHU-1K-MP
long sensor tube aside



GRHU-2K-MP
long sensor tube bottom

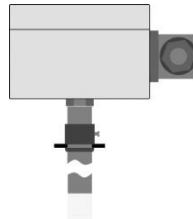

GRHU-MP-Kabel
separated sensor tube

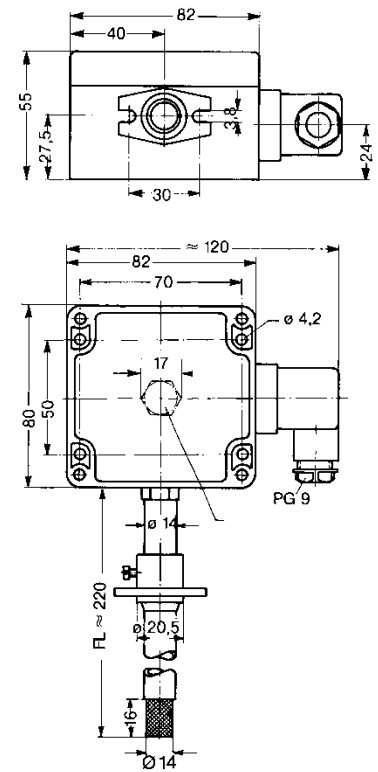

8 Display Functions

8.1 Measuring display

During normal operation the "Option" display value displayed.
 By pressing key 1 (SET) the **temperature** in [°C] or [°F] can be displayed.
 After 5 seconds the display switches automatically back to option display value.



display of selectable humidity value



display temperature

Arrow to Temp indicates temperature display

If the relative humidity in [%] should be shown, although other display is selected (e.g. dew point temperature, mixing ratio...):

press ▼ and ▲ simultaneous display changes between 'r.H.' and measurand

8.2 Min/Max Value Memory

- watch Min values (Lo): press ▼ shortly once
- watch Max values (Hi): press ▲ shortly once
- restore current values: press ▼ or ▲ once again
- clear Min-values: press ▼ for 2 seconds
- clear Max-values: press ▲ for 2 seconds

- display changes between 'Lo' and Min values
- display changes between 'Hi' and Max values
- current values are displayed
- Min values are cleared. Display shows shortly 'CLr'.
- Max values are cleared. Display shows shortly 'CLr'.

After 10 seconds the currently measured values will be displayed again.

8.3 Usage of Unit-Labels

As the transmitter is a multiple purpose device, many different display units are possible, e.g. g/kg, g/m³.

Therefore unit-labels (within scope of supply) can be shoved between the case cover and the front foil behind the **transparent unit-window**.

To replace a label, unscrew the cover, pull out the old label (if present) and shove in the new one.

The unit depends on the configuration settings "Unit"!

Please refer to table in chapter "10 Configuration of the device"

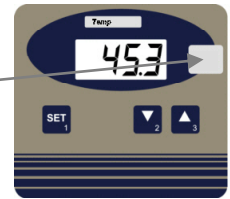

9 Error and system messages

Display	Description	Possible fault cause	Remedy
Err.1	Measuring range exceeded	Wrong signal	Temperature above 120°C not allowed.
Err.2	Measuring value below measuring range	Wrong signal	Temperature below -40°C not allowed.
Err.3	Display range has been exceeded	Value >9999	Check settings
Err.7	System fault	Error in device	Disconnect from supply and reconnect. If error remains: return to manufacturer
Err.9	Sensor error	Sensor or cable defective	Check sensors, cable and connections, damages visible?
Er.11	Calculation not possible	Calculation variable missing or invalid	Check temperature
8.8.8.8	Segment test	The transducer performs a display test for 2 seconds after power up. After that it will change to the display of the measuring.	

10 Configuration of the device

Follow these instructions to configure the functions of the device:

- Press **SET** until the first parameter *Unit* appears in the display
- If a parameter should be changed, press ▼ or ▲,
The device changed to the setting – edit with ▼ or ▲
- Confirm the value with **SET**
- Jump to the next parameter with **SET**.

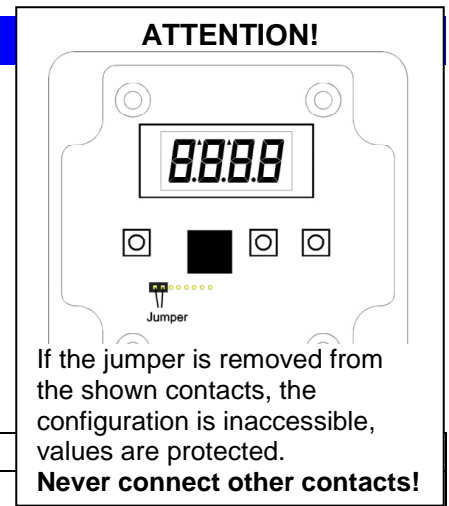

Parameter	value	information
SET	▼ and ▲	
Unit	Unit and Range of humidity display <i>factory setting: rel.H</i>	
	reL.H	0.0 100.0 % relative air humidity
	F.AbS	0.0 ... 200.0 g/m ³ absolute humidity
	FEU.t	-27.0 ... 60.0 °C wet bulb temperature
	t.d.	-40.0 ... 60.0 °C dew point temperature
	Enth	-25.0 ... 999.9 kJ/kg Enthalpy
	F.G.	0.0 ... 640.0 g/kg Mixing ratio (atmospheric humidity)
Unit + Temp arrow	Unit of temperature displays <i>factory setting: °C</i>	
	°C	Temperatures in °Celsius
	°F	Temperatures in °Fahrenheit
Out.0	Display at zero output of humidity display value (output scaling)	
	-xxx.0 ... +xxx.0	Entry of display value at which the humidity output should deliver 4 mA (or 0V) (<i>factory setting: 0.0</i>)
Out.1	Display at maximum output for humidity display value (output scaling)	
	-xxx.0 ... +xxx.0	Entry of display value at which the humidity output should deliver 20 mA (or 1 V / 10 V) (<i>factory setting: 100.0</i>)
OFFS	Offset correction of humidity measuring *	
	oFF	deactivated (<i>factory setting</i>)
	-5.0 ... +5.0	Selectable from -5.0 to +5.0 % rel. humidity
SCAL	Scale correction of humidity measuring *	
	oFF	deactivated (<i>factory setting</i>)
	-15.00 ... +15.00	Selectable from -15.00 to +15.00 % scale correction
Alt	Altitude input (not at all units available) <i>factory setting: 340</i>	
	-500 ... 9000	-500 ... 9000 m selectable

Pressing **SET** again stores the settings, the instruments restarts (segment test)

Please note: *If there is no key pressed within the menu mode within 2 minutes, the configuration will be cancelled, the entered settings are lost!*

*) if higher values are needed, please check sensor, if necessary return to manufacturer for inspection.
Calculation: corrected value = (measured value – Offset) * (1+Scale/100)

11 Notes to the calibration services

Calibration certificates - DKD-certificates - other certificates:

If device should be certificated for its accuracy, it is the best solution to return it with the referring sensors to the manufacturer. (please state desired test values, e.g. 70 %RH)

Only the manufacturer is capable to do efficient recalibration if necessary to get results of highest accuracy! Humidity transmitters are subject to ageing. For optimum measuring precision we recommend a regular adjusting at the manufacturer (e.g. every 2nd year). Cleaning and checking of the sensors is part of the service.

12 Specification

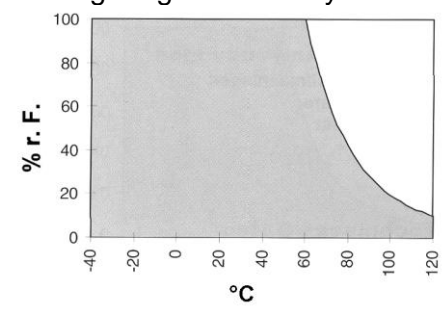
Display ranges humidity	Relative air humidity: 0.0 ... 100.0 %RH Wet bulb temperature: -27.0 ... 60.0 °C (or -16,6 ... 140,0 °F) Dew point temperature: -40.0 ... 60.0 °C (or -40,0 ... 140,0 °F) Enthalpy: -25.0 ... 999.9 kJ/kg Mixing ratio (atmospheric humidity): 0.0 ... 640.0 g/kg absolute humidity: 0.0 ... 200.0 g/m ³	
Recommended humidity measuring range	Standard: 20.0 ... 80.0 %RH Option "high humidity": 5.0 ... 95.0 %RH	Working range of humidity sensor: 
Meas. range temperature	-40.0 ... 120.0 °C or -40.0 ... 248.0 °F	
Accuracy Display	(at nom. temperature 25°C) Rel. Air humidity: ±2.5 %RH (<i>within recommended measuring range</i>) Temperature: ±0.4% of meas. value. ±0.2°C ± 0.2% FS	
Add. Output signal		
Media	Non corrosive gasses	
Sensor	capacitive polymer humidity sensor and Pt1000	
Temperature compensation	automatic	
Meas. frequency	1 per second	
Adjusting	Digital offset and scale adjustment for humidity and temperature	
Min-/Max-value memory	Min and max measured values are stored	
Output signal	refer to type plate,	
Scaling	both freely scalable by entering display values for 4mA (resp. 0V) and 20mA (resp. 1V/10V) output	
Connection	4 - 20 mA (2-wire) Voltage (3- / 4-wire)	
Auxiliary energy:	4 - 20 mA: U _v = 12 - 30 V DC 0-1V: U _v = 12 - 30 V DC, max. 10mA 0-10V: U _v = 18 - 30 V DC, max. 10mA	
Perm. impedance	4 - 20 mA: $R_A(\text{Ohm}) < ((U_v - 12V) / 0,02A)$ <i>example: for U_v = 18V: $R_A < (18V - 12V) / 0.02A \Rightarrow R_A < 300 \text{ Ohm}$</i>	
Permissible load	0 - 1 (10) V: $R_L(\text{Ohm}) > 3000 \text{ Ohm}$	
Display	approx. 10 mm high, 4-digit LCD-display	
Operating elements	3 keys	
Ambient conditions		
Nom. temperature	25°C	
Operating temperature	Electronics: -25 ... 50 °C, sensor head and shaft: -40 ... 100 °C, short time 120 °C for Option "SHUT": sensor head max. 80 °C	
Relative humidity	Electronics: 0 ... 95 %RH (not condensing)	
Storage temperature	-25 ... 70 °C	
Housing	ABS (IP65, except sensor head)	
Dimensions	82 x 80 x 55 mm (without elbow-type plug and sensor tube) for Option "Kabel": Sensor head Ø14mm*68mm, 1m teflon cable, high humidity sensor	
Mounting	Holes for wall mounting (in housing - accessible after cover has been removed).	
Mounting distance	50 x 70 mm, max. shaft diameter of mounting screws is 4 mm	
Electrical connection	Elbow-type plug conforming to DIN 43650 (IP65), max. wire cross section: 1.5 mm ² , wire/cable diameter from 4.5 to 7 mm	
EMC	The device corresponds to the essential protection ratings established in the Regulations of the Council for the Approximation of Legislation for the member countries regarding electromagnetic compatibility (2004/108/EG). In accordance with EN 61326-1: 2006, additional errors: <1 % FS. When connecting long leads adequate measures against voltage surges have to be taken.	