



## Operating manual

## Quick-Response Thermometer

as of version 4.0

# GMH 3201



- ☞ Please carefully read these instructions before use!
- ☞ Please consider the safety instructions!
- ☞ Please keep for future reference!



## Index

<b>1 GENERAL NOTE .....</b>	<b>2</b>
<b>2 SAFETY .....</b>	<b>3</b>
2.1 INTENDED USE .....	3
2.2 SAFETY SIGNS AND SYMBOLS .....	3
2.3 SAFETY GUIDELINES .....	4
<b>3 PRODUCT SPECIFICATION.....</b>	<b>5</b>
3.1 SCOPE OF DELIVERY .....	5
3.2 OPERATION AND MAINTENANCE ADVICE .....	5
<b>4 HANDLING .....</b>	<b>6</b>
4.1 DISPLAY .....	6
4.2 BASIC OPERATION.....	6
4.3 CONNECTIONS .....	6
4.4 POP-UP CLIP.....	7
<b>5 START OPERATION.....</b>	<b>7</b>
<b>6 DEVICE CONFIGURATION.....</b>	<b>8</b>
<b>7 REMARKS TO SPECIAL FEATURES .....</b>	<b>8</b>
7.1 POWER OFF TIME.....	8
<b>8 ADJUSTMENT .....</b>	<b>9</b>
8.1 ZERO DISPLACEMENT.....	9
8.2 SCALE CORRECTION.....	9
8.3 CALIBRATION SERVICES.....	9
<b>9 FAULT AND SYSTEM MESSAGES.....</b>	<b>10</b>
<b>10 RESHIPMENT AND DISPOSAL.....</b>	<b>11</b>
10.1 RESHIPMENT.....	11
10.2 DISPOSAL .....	11
10.3 DECOMMISSIONING .....	11
<b>11 SPECIFICATION.....</b>	<b>12</b>

## 1 General Note

Read this document carefully and get used to the operation of the device before you use it. Keep this document within easy reach near the device for consulting in case of doubt.

## 2 Safety

### 2.1 Intended Use

This device is designed for temperature measurement.

You can plug in a thermocouple sensor with Miniature-DIN-plug.

The device features a lot of useful features as for example hold, correction factor for surface measurement, interface etc.

Personnel which starts up, operates and maintains the device has to have sufficient knowledge of the measuring procedure and the meaning of the resulting measured values, this manual delivers a valuable help for this. The instructions of the manual have to be understood, regarded and followed.

To be sure that there's no risk arising due to misinterpretation of measured values, the operator must have further knowledge in case of doubt - the user is liable for any harm/damage resulting from misinterpretation due to insufficient knowledge.

The manufacturer will assume no liability or warranty in case of usage for other purpose than the intended one, ignoring this manual, operating by unqualified staff as well as unauthorized modifications to the device.

The safety requirements (see below) have to be observed.

The device must be used only according to its intended purpose and under suitable conditions.

Use the device carefully and according to its technical data (do not throw it, strike it, ...). Protect the device from dirt.

### 2.2 Safety signs and symbols

Warnings are labelled in this document with the followings signs:



**Caution!** This symbol warns of imminent danger, death, serious injuries and significant damage to property at non-observance.



**Attention!** This symbol warns of possible dangers or dangerous situations which can provoke damage to the device or environment at non-observance.









**Note!** This symbol point out processes which can indirectly influence operation, possibly cause incorrect measurement or provoke unforeseen reactions at non-observance.

## 2.3 Safety guidelines

This device has been designed and tested in accordance with the safety regulations for electronic devices.

However, its trouble-free operation and reliability cannot be guaranteed unless the standard safety measures and special safety advises given in this manual will be adhered to when using the device.

Trouble-free operation and reliability of the device can only be guaranteed if the device is not subjected to any other climatic conditions than those stated under chapter 11 Specification.

1.  If there is a risk whatsoever involved in running it, the device has to be switched off immediately and to be marked accordingly to avoid re-starting.  
Operator safety may be a risk if:
  - there is visible damage to the device
  - the device is not working as specified
  - the device has been stored under unsuitable conditions for a longer time. In case of doubt, please return device to manufacturer for repair or maintenance.
2.  Do not use these products as safety or emergency stop devices or in any other application where failure of the product could result in personal injury or material damage.  
Failure to comply with these instructions could result in death or serious injury and material damage.
3.  This device must not be used at potentially explosive areas! The usage of this device at potentially explosive areas increases danger of deflagration, explosion or fire due to sparking.
4.  This device is not constructed for use in medical applications.
5.  This device must not be run with a defective or damaged power supply unit. Danger to life due to electrical shock!
6.  Temperature sensor:  
There is a risk of stitch injury by using insertion probs. When measuring high temperatures there is a risk of burn, also due to residual heat of the sensor tube.
7.  Consider when measuring in food:  
The device housing is not construed for the permanent contact with food.  
Keep in mind to use temperature-probes which are suitable for the use in food only.

## 3 Product Specification

### 3.1 Scope of delivery

The scope of supply includes:

- Device with battery
- Operating manual

### 3.2 Operation and maintenance advice

- **Battery operation:**

If 'bAt' is shown in the lower display the battery has been used up and needs to be replaced. However, the device will operate correctly for a certain time. If 'bAt' is shown in the upper display the voltage is too low to operate the device; the battery has been completely used up.



***The battery has to be taken out, when storing device above 50 °C.  
We recommend taking out battery if device is not used for a longer period of time.***

***After recommissioning the real-time clock has to be set again.***

- Treat device and sensor carefully. Use only in accordance with above specification. (do not throw, hit against etc.). Protect plug and socket from soiling.
- Connecting/changing sensors



To disconnect thermocouple sensor plug do not pull at the cable but at the plug

**Selection of types of thermocouples:** Prior to carrying out a measurement make sure to check if device is set to the thermocouple type used (type is shown on the display shortly after unit has been switched on). Unless the correct thermocouple is set, temperature measurements will be incorrect!

## 4 Handling

### 4.1 Display

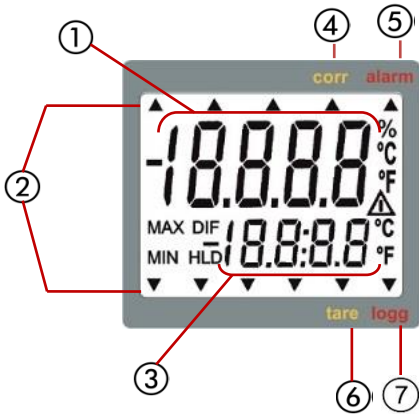

- 1 **Main display:** measuring value

---

- 2 Arrows show display options

---

- 3 **Secondary display:** display of min/max, hold  
**corr:** appears if offset-, scale correction or correction for surface measurement is <> state of delivery.

---

- 5 **alarm:** not in use

---

- 6 **tare:** not in use

---

- 7 **logg:** not in use

### 4.2 Basic Operation

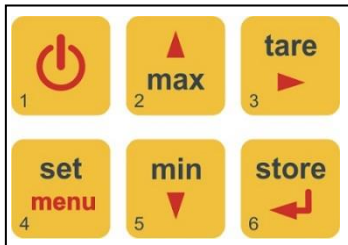

**On / Off**



**min/max measuring:**

press short: shows the min./max. value

+

press again: hides min./max. value



press 2 sec.: clears particular value



*Not in use*



**Set/Menu:**

press long: calling of configuration



**Store/Quit:**

press short: hold-function, the last measuring value will be held in the secondary display.

press again: hides the value

### 4.3 Connections

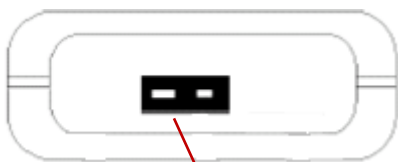

**Sensor Connection**

## 4.4 Pop-up clip

### Handling:

- Pull at label “open” in order to swing open the pop-up clip.
- Pull at label “open” again to swing open the pop-up clip further.

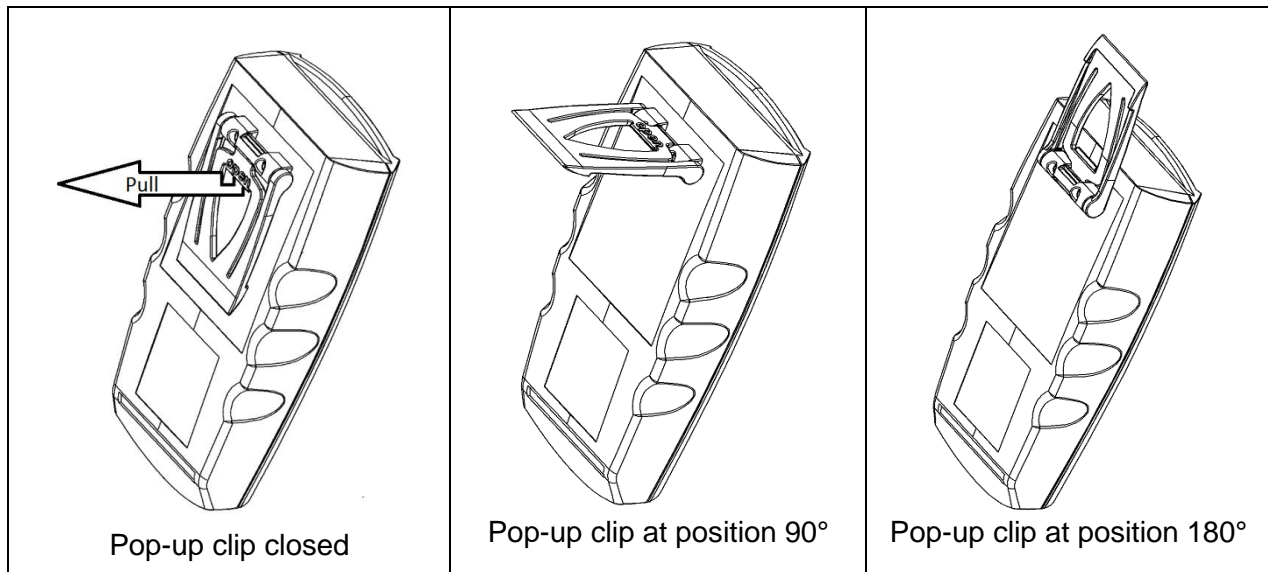

### Function:

- The device with a closed pop-up clip can be plainly laid onto a table or attached to a belt, etc.
- The device with pop-up clip at position 90° can be set up on a table, etc.
- The device with pop-up clip at position 180° can be suspended from a screw or the magnetic holder GMH 1300.

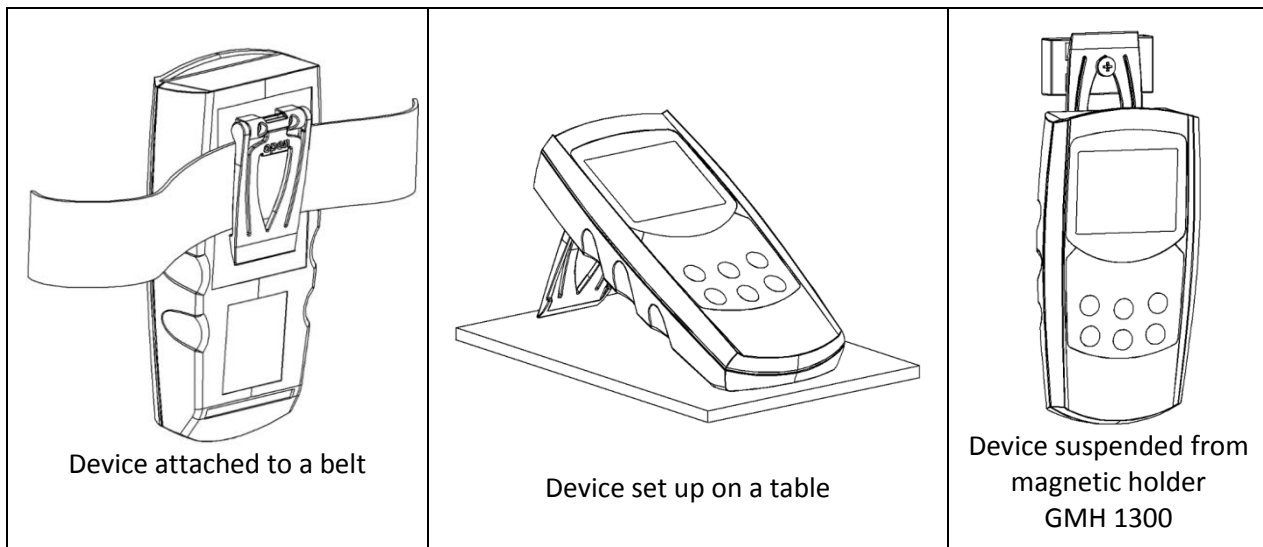

## 5 Start Operation

Connect sensor and turn on device via  key.

After segment test  the device is ready for measuring.

## 6 Device Configuration

To change device settings, press **Set** (key 4) for 2 seconds. This will call the configuration menu.

The parameters can be changed with **▲** (key 2) or **▼** (key 5).

Press **Set** again to go to the next setting.

**Store** (key 6) finishes the configuration and returns to standard measuring operation.

Parameter	Values	Meaning
MENU	KEY ▲ or ▼	
rES	0.1°	<b>Resolution:</b> 0,1°C or °F
	1°	<b>Resolution:</b> 1°C or °F
Unit	°C	Values in °C
	°F	Values in °F
P.oFF	1-120	<b>Auto Power Off</b> time in minutes
	oFF	Auto Power Off deactivated
OFS.	-10.0°C..10.0°C or -18.0°F..10.0°F	The <b>offset of sensor</b> will be displaced by this value to compensate for deviations in the Sensor or in the measuring device.
	oFF:	Zero point displacement is deactivated (=0.0°)
SCL.	-5.00..5.00 %	The measuring <b>scale of sensor</b> will be changed by this factor [%] to compensate deviations of temperature probe or measuring device.
	oFF:	Correction factor is deactivated (=0.000)

## 7 Remarks To Special Features

### 7.1 Power off Time

If there won't be pressed any key and no interface communication takes place for the time of the power off time setting (P.Off), the device will be switched off automatically to save battery power.

If P.oFF = oFF then the automatic switch off is deactivated.



## 8 Adjustment

### 8.1 Zero Displacement

A zero displacement can be carried out for the measured value:

$$\text{value displayed} = \text{value measured} - \text{offset}$$

Standard setting: 'off' = 0.0°, i.e. no zero displacement will be carried out. Together with the scale correction (see below) this factor is mainly used to compensate for sensor deviations. Input is in the display unit.

### 8.2 Scale Correction

This setting influences the scale of the measuring (factor is in %):

$$\text{displayed value} = \text{measured value} * (1 + \text{Scal}/100)$$

Standard setting: 'off' = 0.000, i.e. value is not corrected. Together with the zero displacement (see above) this factor is mainly used to compensate for sensor deviations.



### 8.3 Calibration Services

Calibration certificates – DKD-certificates – other certificates:

If device should be certificated for its accuracy, it is the best solution to return it to the manufacturer.

Only the manufacturer is capable to do efficient recalibration if necessary to get results of highest accuracy!

## 9 Fault and System Messages

Display	Meaning	What to do?
	Low battery power, device will only continue operation for a short period of time	Replace battery
	Battery empty	Replace battery
	Mains operation without battery: wrong voltage	Check power supply, replace it when necessary
	No sensor connected	Connect sensor
	Connected sensor or device defective	If 2nd sensor available, check if device is ok. Return defective device/sensor to manufacturer for repair
	Value extremely out of measuring range	Check: right thermocouple selected.
No display or confused characters, device does not react on keypress	Battery empty	Replace battery
	System error	Disconnect battery and power supplies, wait shortly, then reconnect
	Device defective	Return to manufacturer for repair
<b>Err.1</b>	Measured value above allowable range	Check: correct thermocouple selected. Temperature not within sensor range? -> measuring value to high!
	Sensor defective	Return to manufacturer for repair
<b>Err.2</b>	Measured value below allowable range	Check: correct thermocouple selected. Temperature not within sensor range? -> measuring value to low!
	Sensor defective	Return to manufacturer for repair
<b>Err.3</b>	Display range overflow	Check: value above 1999.9 -> too high to be displayed
<b>Err.4</b>	Display range underflow	Check: value below -1999.9 -> too low
<b>Er.11</b>	Value could not be calculated	A value, that is necessary for the calculation, is not available (no sensor) or faulty (over- / underflow)
	Calculation overflow happened	Choose different unit
<b>Err.7</b>	System error	Check allowed working temperature of the device Return to manufacturer for repair

## 10 Reshipment and disposal

### 10.1 Reshipment



All devices returned to the manufacturer have to be free of any residual of measuring media and other hazardous substances. Measuring residuals at housing or sensor may be a risk for persons or environment



Use an adequate transport package for reshipment, especially for fully functional devices. Please make sure that the device is protected in the package by enough packing materials.

### 10.2 Disposal



Dispense exhausted batteries at destined gathering places. The device must not be disposed in the unsorted municipal waste! Send the device directly to us (sufficiently stamped), considering the above if it should be disposed. We will dispose the device appropriate and environmentally sound.

Private user can return the device at the municipal collection points for small electrical appliances.

### 10.3 Decommissioning

When decommissioning, connections **must not** be in a condition that causes the connected evaluation electronics (e.g. interface) to trigger unexpected switching operations.

## 11 Specification

<b>Thermocouples:</b>	K (NiCr-Ni)	
<b>Resolution:</b>	0.1°C or 1°C	0.1°F or 1°F
<b>Measuring range:</b>	-220.0 ... +1372.0°C	-364.0 ... +1999.9°F
<b>Accuracy:</b>	(for thermocouples acc. to DIN EN 60584) ±1 digit (at nominal temperature ± 5K) Type K ± (0.5°C. + 0.2% of measured value)	
<b>Temperature drift:</b>	0.01 %/K	
<b>Point of comparison:</b>	±0.3 °C	
<b>Nominal temperature:</b>	25 °C	
<b>Measuring rate:</b>	4 meas./sec	
<b>Sensor connection:</b>	connection socket for miniature DIN-plug type K	
<b>Display:</b>	Two 4 ½ digit LCDs (12.4 mm high and 7 mm high) for measuring values, and for min/ max memories, hold function, etc. as well as additional functional arrows.	
<b>Pushbuttons:</b>	6 membrane keys	
<b>Power supply:</b>	9V battery (included in scope of supply)	
Power consumption:	approx. 1.0 mA	
Low battery warning:	' bAt '	
<b>Working conditions:</b>	-25 ... +50 °C, 0 ... 95 %RH (not condensing)	
<b>Storage temperature:</b>	-25 ... +70 °C	
<b>Housing:</b>	impact-resistant ABS, membrane keyboard, transparent panel, Front side IP65	
Dimensions:	142 x 71 x 26 mm (L x W x D)	
Weight:	approx. 155 g	
<b>EMC:</b>	The instruments confirm to following European Directives: 2014/30/EU EMC Directive 2011/65/EU RoHS Applied harmonized standards: EN 61326-1 : 2013 emissions level: class B emi immunity according to table 3 and A.1 Additional fault: <1%  EN 50581 : 2012	