

Oxygen meter for dissolved oxygen
with integrated temperature and pressure measuring

As of Version 1.0

Operating Manual

GMH 3651



Please keep for future reference!



WEEE-Reg.-Nr. DE 93889386

Contents

1	GENERAL NOTE	2
2	DESIGNATED USE	3
3	SAFETY	3
3.1	SAFETY SIGNS AND SYMBOLS	3
3.2	SAFETY GUIDELINES	3
4	PRODUCT DESCRIPTION	4
4.1	SCOPE OF SUPPLY	4
4.2	OPERATION AND MAINTENANCE ADVICE	4
4.3	START OF OPERATION	4
4.4	CONNECTIONS	5
4.5	DISPLAY ELEMENTS	5
4.6	PUSHBUTTONS	5
4.7	POP-UP CLIP	6
5	CONFIGURATION	7
6	THE OXYGEN SENSOR	9
6.1	DESIGN OF SENSOR GWO 3600	9
6.2	ELECTRODE MAINTENANCE	9
7	OXYGEN MEASURING - PLEASE NOTE	10
7.1	CORRECTION OF SALINITY ('SAL')	10
7.2	AMBIENT PRESSURE AND MEASURING DEPTH OF THE ELECTRODE	10
7.2.1	<i>Measurement without Water depth measuring assembly: Menü dEPt = OFF</i>	10
7.2.2	<i>Measurement without Water depth measuring assembly TMV 3600 (dEPt = On)</i>	10
8	CALIBRATION OF THE SENSOR	11
8.1	ONE POINT CALIBRATION ('CAL 1-PT')	11
8.2	2 / 3-POINT CALIBRATION ('CAL 2-PT, CAL 3-PT')	12
8.3	EVALUATION OF SENSOR STATE (ELEC)	12
9	OPERATION OF THE LOGGER	13
9.1	„FUNC-STOR“: STORING SINGLE MEASUREMENT SETS	13
9.2	„FUNC-CYCL“: AUTOMATIC RECORDING WITH SELECTABLE LOGGER-CYCLE-TIME	14
10	INSPECTION OF THE ACCURACY / ADJUSTMENT SERVICES	14
11	OUTPUT	15
11.1	INTERFACE - BASE ADDRESS ('ADR.')	15
11.2	ANALOGUE OUTPUT – SCALING WITH DAC.0 AND DAC.1	15
12	GLP	16
12.1	CALIBRATION INTERVAL (CInt)	16
12.2	CALIBRATION STORAGE (READ CAL)	16
13	ALARM („AL.“)	16
14	REAL TIME CLOCK („CLOC“)	16
15	ERROR AND SYSTEM MESSAGES	17
16	SPECIFICATION	18
17	RESHIPMENT AND DISPOSAL	18

1 General Note

Read this document carefully and get used to the operation of the device before you use it. Keep this document within reach for consulting in case of doubt.

If the device is stored at temperatures above 50°C the battery has to be removed from the device.

NOTE: *We recommend taking out battery if device is not used for a longer period of time.
Risk of leakage!*



2 Designated Use

The GMH 3651 is measuring dissolved oxygen in Water.

The measuring is performed by means of a suitable oxygen sensor (included in supply in standard instrument) connected to the Mini-DIN socket, the sensor measures at the membrane at the tip of the sensor. Due to the properties of the sensor, it has to be calibrated regularly (e.g. at fresh air = 20.95%) to get precise values. If the sensor is used up, this will be detected during the calibration, the sensor has to be regenerated or replaced before continuing with measuring.

The safety requirements (see below) have to be observed.

The device must be used only according to its intended purpose and under suitable conditions.

Use the device carefully and according to its technical data (do not throw it, strike it, ...)

Protect the device from dirt.

3 Safety

3.1 Safety signs and symbols

Warnings are labeled in this document with the followings signs:



Caution! This symbol warns of imminent danger, death, serious injuries and significant damage to property at non-observance.



Attention! This symbol warns of possible dangers or dangerous situations which can provoke damage to the device or environment at non-observance.



Note! This symbol point out processes which can indirectly influence operation or provoke unforeseen reactions at non-observance.

3.2 Safety guidelines

This device has been designed and tested in accordance with the safety regulations for electronic devices. However, its trouble-free operation and reliability cannot be guaranteed unless the standard safety measures and special safety advises given in this manual will be adhered to when using the device.

1. Trouble-free operation and reliability of the device can only be guaranteed if the device is not subjected to any other climatic conditions than those stated under "Specification".
If the device is transported from a cold to a warm environment condensation may cause in a failure. In such case make sure the device temperature has adjusted to the ambient before trying a new start-up.

2.  If there is a risk whatsoever involved in running it, the device has to be switched off immediately and to be marked accordingly to avoid re-starting.



Operator safety may be a risk if:

- there is visible damage to the device
- the device is not working as specified
- the device has been stored under unsuitable conditions for a longer time.

In case of doubt, please return device to manufacturer for repair or maintenance.

3.  Do not use these products as safety or emergency stop devices or in any other application where failure of the product could result in personal injury or material damage.
Failure to comply with these instructions could result in death or serious injury and material damage.



4.  This device must not be used at potentially explosive areas! The usage of this device at potentially explosive areas increases danger of deflagration, explosion or fire due to sparking.



4 Product Description

4.1 Scope of supply

The scope of supply includes:

- GMH 3651 with 9V-battery
- Oxygen sensor GWO 3600
- Operating Manual

4.2 Operation and maintenance advice

1. Battery operation

If \triangle and 'bAt' are shown in the lower display the battery has been used up and needs to be replaced. However, the device will operate correctly for a certain time. If 'bAt' is shown in the upper display the voltage is too low to operate the device; the battery has been completely used up.



The battery has to be taken out, when storing device above 50 °C.

We recommend taking out battery if device is not used for a longer period of time.

After recommissioning the real-time clock has to be set again.

2. Mains operation with power supply

When using a power supply please note that operating voltage has to be 10.5 to 12 V DC.



Do not apply overvoltage!! Cheap 12V-power supplies often have excessive no-load voltage.

We, therefore, recommend using regulated voltage power supplies.

Trouble-free operation is guaranteed by our power supply GNG10/3000.

Prior to connecting the power supply to the mains make sure that the operating voltage stated at the power supply is identical to the mains voltage.

3. Treat device and sensor carefully. Use only in accordance with above specification. (do not throw, hit against etc.). Protect plug and socket from soiling.

4.3 Start of Operation

Switch the device on with the key "ON OFF". The Instrument is performing a self diagnosis, during this time all display segment are shown.

Afterwards the instrument signals, if it was user adjusted („Err“)

The device starts measurement afterwards.

4.4 Connections

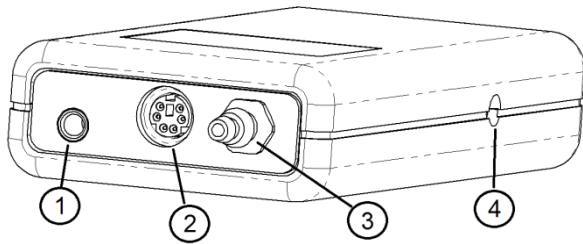

2. **Sensor connection** MiniDIN

3. **Pressure Port:** Tube Connection for ambient pressure compensation of oxygen Sensor

4. **Power supply:** d.c.connector (internal pin Ø 1.9 mm) for external 10.5-12V direct voltage supply

1. **Output:** Operation as **interface** for the connection of galvanically isolated adapters (accessories: GRS 3100, USB 3100)

Operation as **analogue output:** connection via suitable analogue cable

Attention: The mode of operation has to be configured (p.r.t Chapter 5) and influences the power consumption.

4.5 Display elements

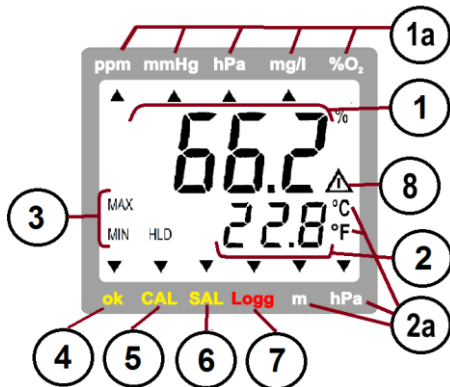

1 = **Main Display:**

Display of the oxygen value, please refer to chapter 5, [h 2]

1a = **display unit:**

(change with -key)

2 = **secondary display:**

Display of sensor temperature or absolute pressure (alternating, please refer to Chapter 5. Lcd.2)

2a = **display unit:**

Special elements:

3 = **MIN/MAX/HLD:**

Shows, if minimum/maximum/ memorized measuring value is in display Signals, if oxygen and temperature values are stable

4 = **ok-arrow:**

Signals, if automatic calibration is in progress

5 = **CAL-arrow:**

Signals, that the salinity correction is activated

7 = **Logg-arrow**

Shows, if logger function is chosen. Is blinking, if cyclic logger is running

8 = **Warning sign:**

Signals weak battery or other warning message

4.6 Pushbuttons

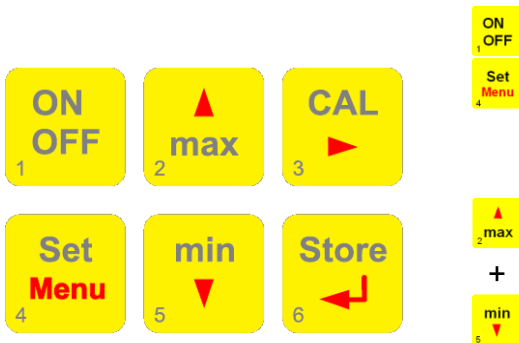

On / off key

Set/Menu

Press 2 sec.: (Menu): call configuration menu
Press shortly: Change the oxygen display unit (please refer to chapter 5)

min/max when taking measurements:

press shortly: min. or max. measured oxygen value and referring temperature and pressure (depth) values will be displayed

press for 2 sec.: the min. or max. value will be deleted

Configuration: to enter values, or change settings



Store/Enter

- Measuring: with Auto-Hold off: hold and save current measuring value ('HLD' is displayed) with Auto-Hold on: start new measuring, It is finished, when "HLD" shows in display or if logger activated: calling the logger functions (refer to chapter 9)
- Set/Menu: confirm settings, return to measuring



CAL:

- press shortly: display of sensor state rating
- press for 2 sec: start sensor calibration

4.7 Pop-up clip

Handling:

- Pull at label “open” in order to swing open the pop-up clip.
- Pull at label “open” again to swing open the pop-up clip further.

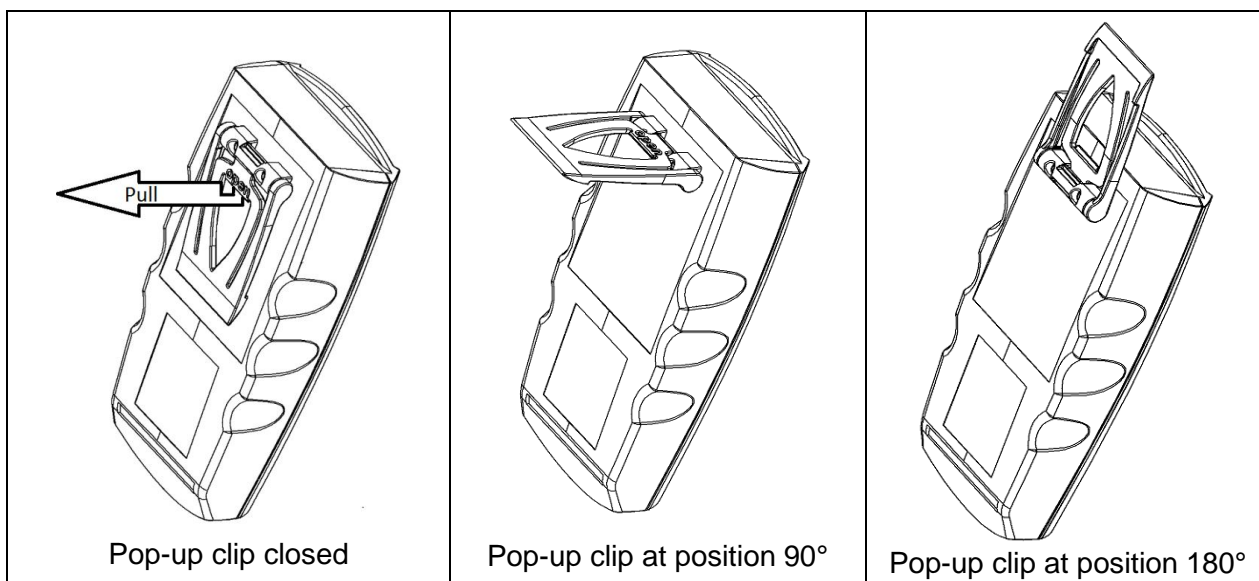

Function:



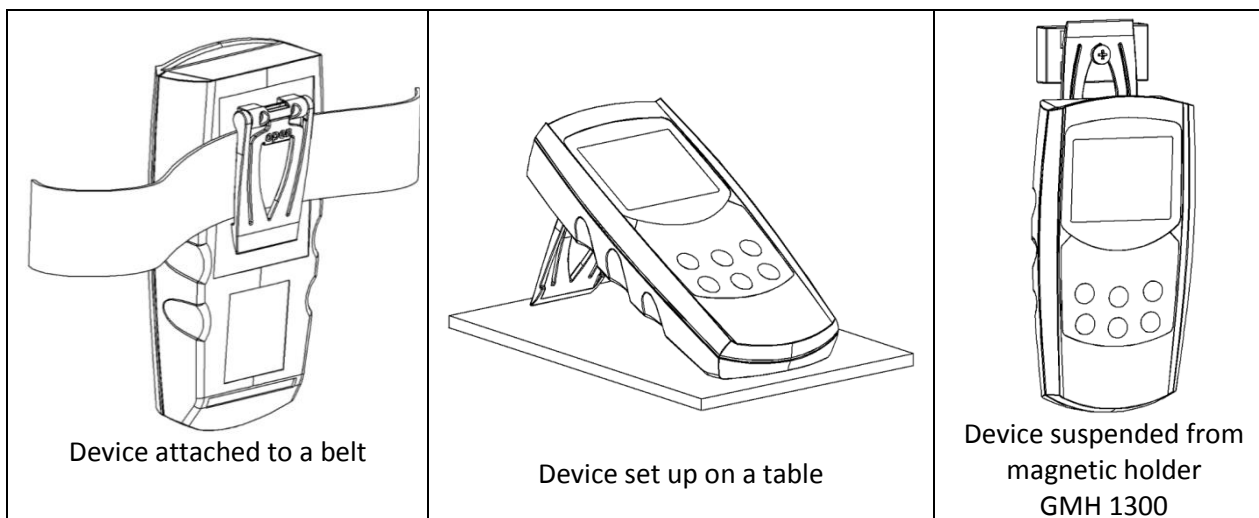

- The device with a closed pop-up clip can be plainly laid onto a table or attached to a belt, etc.
- The device with pop-up clip at position 90° can be set up on a table, etc.
- The device with pop-up clip at position 180° can be suspended from a screw or the magnetic holder GMH 1300.







5 Configuration



Some menu points depend on current device settings.

To change device settings, press „Menu“  for 2 seconds. This will activate the configuration menu (main display: “Set”). Pressing „Menu“  changes between the menus points, pressing  jumps to the referring parameters, which can be selected with key .

The parameters can be changed with  or . Pressing „Menu“  again jumps back to the main configuration menu and saves the settings. "Quit"  finishes the configuration and returns to standard measuring operation.

Menu	Parameter	Value	Description	
key Menu	key ▶	key ▲ or ▼		p.r.t
Set Configuration: General configurations				
SEt CONF	Unit Conc	Conc ppm	Display unit of O ₂ -concentration ppm (identical values like mg/l)	*
		Conc mg/l	Display unit of O ₂ -concentration mg/l (identical values like ppm)	
Ch 2	SAL	%O ₂	Main display shows O ₂ -concentration (mg/l or ppm) or O ₂ -Saturation in % (<i>ex works setting</i>)	
		P O ₂ hPa	Main display shows O ₂ -concentration or O ₂ -partial pressure in hPa	
		P O ₂ mmHg	Main display shows O ₂ -concentration or O ₂ -partial pressure in mmHg	
RES	H ₁	Lo	Best O ₂ resolutions	
		Lo	Low O ₂ resolution, calm value display (standard)	
SAL	SAL	oFF	Salinity correction deactivated (<i>ex works setting</i>)	
		0.1 ... 70.0	Salinity correction activated, Unit ‰ = PSU	
Lcd.2	Lcd.2	t	Second. display always temperature	
		P	Second. display always absolute pressure	
		P t	Second. display alternates between temperature and abs. pressure	
		dEP.t	Depth measuring activated, Second. display alternates between temperature and depth in meter (only with depth accessory TMV 3600)	
Unit t	Unit t	°C	All temperatures in degree Celsius (<i>ex works setting</i>)	
		°F	All temperatures in degree Fahrenheit	
CAL	CAL	Air	The sensor will be calibrated at air or gas (<i>ex works setting</i>)	
		AQUA	The sensor will be calibrated in water	
CALP	CALP	1-PE	Simple one point calibration at air (Air) or at air saturated water (AQUA)	
		2-PE / 3-PE	2 or 3-point calibration at air (Air)/air saturated water (AQUA), or in oxygen/oxygen saturated water or in nitrogen/zero solution	
C.int	C.int	1 ... 365	Calibration reminder period (in days)	
		oFF	No calibration reminder	
Auto HLD	Auto HLD	on	Auto measuring value identification Auto Hold (when logger = off)	
		oFF	Standard hold function on key press (when logger = off)	
P.oFF	P.oFF	1 ... 120	Power-off delay in minutes. Device will be automatically switched off as soon as this time has elapsed if no key is pressed/no interface communication takes place. (<i>ex works setting</i> 20min)	
		oFF	Automatic power-off function deactivated (continuous operation)	
Out	Out	oFF	Interface off -> minimal power consumption	
		SEr	Serial interface activated (<i>ex works setting</i>)	
		dAC	Analogue output activated	
Adr	Adr	01, 11, 21, ... 91	Base address for serial interface communication (<i>ex works setting</i> 01)	

dA,n	Conc	Analogue output is showing concentration in mg/l or in ppm		
	SRt or P O2	Analogue output is showing partial pressure in %, hPa or mmHg (£h 2)		
dARC0	0.0...100.0 %O ₂	Measuring value which should correspond to output 0 V		
dARC1	0.0...100.0 %O ₂	Measuring value which should correspond to output 1 V e.g. 100.0 % -> 1 V (ex works 100,0 %O ₂)		

Set Corr: Input adjustment					
SEt Corr	OFF5 °C or °F	-5.0 °C .. 5.0 °C or -9.0 °F .. 9.0 °F	The zero point of the temperature measuring is shifted for the entered value. This can be used to compensate sensor and instrument deviations		
		oFF	No zero adjustment for temperature measurement (=0.0°)		
		SCAL °C or °F	-5.00 ... 5.00 %	The slope of the temperature measurement is corrected by this value. This can be used to compensate sensor and instrument deviations	
		oFF	No slope adjustment for temperature measurement (=0.00)		
OFF5 hPa	-20 .. 20 hPa	The zero point of the pressure measuring is shifted for the entered value. This can be used to compensate sensor deviations			
		oFF	No zero adjustment for pressure measurement (=0.0°)		

Set Alarm:					
SEt AL	AL. 1	on / no.5o	Monitoring Oxygen: Alarm on with buzzer / Alarm on without buzzer		
		oFF	No alarm monitoring for oxygen		
	AL,n	Conc	Monitoring Oxygen: Concentration in %		
		P. O2	Monitoring Oxygen: Partial pressure in hPa or mmHg		
	A1Lo	e.g. 0.0..100.0 %	Min alarm limit oxygen (not if AL. 1. oFF)		
	A1hi	e.g. 0.0..100.0 %	Max alarm limit oxygen (not if AL. 1. oFF)		
	AL. 2	on / no.5o	Temperature monitoring : Alarm on with buzzer / Alarm on without buzzer		
		oFF	No alarm monitoring for temperature		
A2Lo	-5.0 ..+ 50.0 °C	Min alarm limit temperature (not if AL. 2. oFF)			
A2hi	-5.0 ..+ 50.0 °C	Max alarm limit temperature (not if AL. 2. oFF)			

Set Logger					
SEt LoGG	Func	CYCL	Cyclic logger function	*	9
		Stor	Store: manual recording		
		oFF	No logger activated		
	CYCL	0:01 ... 60:00	Cycle time in [minutes:seconds] for cyclic logger	*	
Set Clock					
SEt CLOC	CLOC	HH:MM	Clock: set time	hours:minutes	
	YEAR	YYYY	Year: set year		
	DATE	TT.MM	Date: set date	day.month	



Pressing “menu” and “store” at the same time for more than 2 seconds will reset the device to factory defaults

If there are data sets stored and logger is set to “manual recording” (“Func Stor”) the first menu point displayed is “rEAd Logg” (p.r.t. chapter 9)

If no key is pressed for more than 2 minutes the configuration will be aborted. All changes will not be saved!

6 The Oxygen Sensor

6.1 Design of Sensor GWO 3600

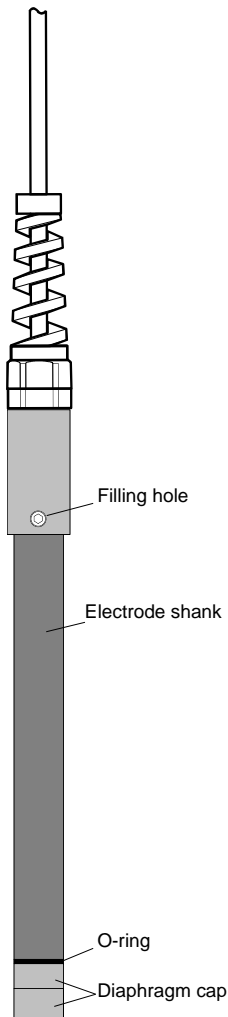

The oxygen electrode is an active electrode consisting of a silver cathode and a lead anode with the electrolyte being potassium hydroxide (KOH). In case of oxygen being present it will be reduced at the silver cathode, i.e. the electrode supplies a current. No oxygen means no current either. The oxygen measurements use up both the silver cathode as well as the lead anode. The electrode is subject to ageing. Therefore, we recommend to maintain the electrode at monthly intervals (p.r.t. 'Electrode maintenance')

Please note: Make it a rule to always store the electrode in a humid environment.



- in the storage flask filled with water
- in another container filled with water

If electrode has not been used for some time, clean diaphragm with soft cloth and remove deposits, if any (algae, bacteria etc.).

Electrode design

The electrode housing is made of PVC. With the exception of the electrode shaft all parts need to be maintained regularly and be replaced if necessary.

- o **Protective flask:** The protective flask is used to moisten the diaphragm. This The prolongs service life of the electrode. The protective flask contains water. Attention! Use water only; never use potassium chloride (KCl); this is only required for storage of pH-electrode.
- o **Diaphragm head:** the diaphragm head is covered with a teflon diaphragm. It will be filled with KOH electrolyte and screwed onto the electrode shaft (no air bubbles). Damages in the diaphragm, large air bubbles or air bubble rings in the diaphragm head will result in erroneous measurements. This may also be the reason for errors in the calibration. The diaphragm head is a spare part and can be ordered individually.
- o **Filling hole:** If the electrode is used at high temperatures or if it has been stored without its protective flask for a longer period of time, some electrolyte will be lost due to evaporation. During maintenance make it a rule to unscrew diaphragm head, remove locking screws and top up electrolyte using a syringe. Replace and tighten locking screws.



Attention when working with electrolyte! The electrolyte is corrosive! (strong base, KOH)

6.2 Electrode Maintenance

If electrode can no longer be calibrated, it needs maintenance.

Attention! The electrolyte is a corrosive.

To maintain electrode please proceed as follows:

1. Unscrew diaphragm head and wipe clean of electrolyte solution using a paper cloth. Do not touch electrolyte. If your skin had contact with electrolyte, immediately rinse thoroughly with clear water.
2. Clean silver cathode with sand paper (grain size 240). Do not polish silver cathode, surface should stay rough. Remove all dust.
3. Remove filling screw and top up lost electrolyte (e.g. using disposable syringe)
4. Put back and tighten filling screw.
5. Top up diaphragm head with electrolyte avoiding air bubbles and place on table (cover table with absorbent paper first).
6. Keep electrode in a vertical position and screw diaphragm head to the electrode from the bottom. Electrolyte will be forced out of the diaphragm head and spill over (put on disposable gloves or use paper towel to touch diaphragm head).
7. Wipe up excess electrolyte with paper cloth.

8. Check cathode for air bubbles.

If there are large air bubbles, remove diaphragm head again and repeat process as of point 5. If O-ring has been damaged, it has to be replaced.

When maintenance has been completed plug on protective flask. Re-connect electrode to measuring device and wait for at least 3 hours till electrode can be calibrated..

7 Oxygen Measuring - please note

Please observe the following points when measuring dissolved oxygen:

- **For measuring remove the protective flask.**
- **Do not disconnect electrode from device.**
 - If electrode has been disconnected, wait 2 - 3 hours till the final electrode signal has settled before carrying out measurements or a calibration.
- **Electrode needs to be calibrated** (p.r.t. 'How to calibrate oxygen electrode')
- **The temperatures of the electrode and of the liquid to be measured have to be identical** (if necessary, wait till temperatures match)
- **The Electrode has to be submerged at least 3 cm into the liquid to be measured**
- **The measured liquid has to stream along the electrode membrane with at least 30 cm/sec** for measurements to be sufficiently accurate: either stir continuously or use agitator.
- The electrode measurement is sensitive against shocks!
 - By stirring of the electrode in the measured liquid be careful that the electrode does not hit the container. A vibration of the electrode has a effect to the measured value.
- The **optimum operation position** is: with the sensor inlet pointing downwards

The instrument calculates the oxygen concentration [mg/l], the oxygen saturation [%] and the oxygen partial pressure [hPa] from the electrode signal and the temperature. According to DIN38408-C22 all measurements refer to steam saturated air.

7.1 Correction of salinity ('SAL')

The higher the salinity (salt content) the lower the solubility of oxygen in water, i.e. although the partial oxygen pressure is the same, the quantity of oxygen dissolved in water (mg/l) is lower. Therefore, determination of the oxygen concentration requires entering the salinity of the medium (p.r.t. 'Configuration'). The correction of salinity is based on media on a water basis, whose chemical content is similar to sea water. The corrections are based on the 'International Oceanographic Tables' (IOT).

7.2 Ambient pressure and measuring depth of the electrode

The pressure at the sensor membrane is important for:

- The calculation of the oxygen saturation (%sat).
 - At air water can get 100% saturation. Assumed that there are no oxygen consuming processes (biological degradation, chemical effects) and that there are no oxygen enriching processes (e.g. excessive ventilation or photosynthesis)
- The calculation of oxygen concentration (mg/l or ppm)
- The electrode evaluation at calibration

Therefore it is necessary to compensate the pressure influence via integrated sensor or, like practised with more primitive instruments via tables and manual input of pressure or Elevation above sea level values.

7.2.1 Measurement without Water depth measuring assembly: Menü dEPt = OFF

The integrated pressure sensor is permanently measuring the ambient pressure to:

- Compensate the pressure for the concentration [mg/l or ppm] or saturation [%O₂]
- Pressure compensate the calibration

7.2.2 Measurement without Water depth measuring assembly TMV 3600 (dEPt = On)

Necessary accessory: Water depth measuring assembly TMV 3600.

The pressure sensor measures the hydrostatic pressure to evaluate the measuring depth of the sensor with a resolution of 0.1m

(e.g. for comfortable logging of oxygen profiles in lakes)

Before starting the measuring (during segment test) and during calibration the pressure port has to be at ambient pressure: The reference ambient pressure is taken (display *P_{rEF}* and pressure) and memorized for calculation of saturation [%O₂], and as reference for the hydrostatic depth measuring.

Info: The hydrostatic pressure does not really play a significant role for the calculation of concentration (mg/l or ppm) or saturation [%O₂] up to 100m depth, but it is an important unit to evaluate oxygen layering in waters. Combined with the logger function evaluation can be performed very comfortably!

More detailed Info: Please refer to manual of TMV 3600.

8 Calibration of the Sensor

In order to compensate for ageing of the sensor, the sensor has to be calibrated at regular intervals. The device is equipped with easy-to-use calibration functions: Standard 1-point calibration, sufficient for the most applications and special 2 or 3-point calibration, if high accuracy is needed in extreme measuring. We recommend to calibrate the sensor at least all 7 days, or to get maximum precision, before each measuring series.

If the electrode was dry for one or more days it has to be 'watered' for at least 30 minutes before carrying out a new calibration.

Remove protective flask prior to calibration and wipe diaphragm with a soft piece of cloth

8.1 One Point Calibration ('CAL 1-PT')

The 1-point calibration adjusts the sensor to the oxygen content of the atmosphere (20.95%). You can choose between three modes of calibration for which the electrode has to be prepared accordingly.

Air calibration without accessories ('Cal Air')

The electrode will be exposed to **ambient air**. To protect it from draughts, wrap electrode in a paper towel. (before calibration, expose sensor at least 15 minutes to the ambient air, to let the temperature adjust and to dry membrane)

Depending on the rel. atmospheric humidity [%] and the temperature [°C] a small calibration error cannot be avoided and will have to be accepted. The cooler the air is, the smaller the deviation.

Recommended temperature: < 25°C.

For error compensation please refer to the opposite table.

Note: A correctly calibrated electrode shows 106 - 108% at air and at room temperature.

	20%	40%	60%	80%	100%
5 °C	1.007	1.005	1.003	1.002	1.00
10 °C	1.01	1.007	1.005	1.002	1.00
15 °C	1.014	1.01	1.007	1.003	1.00
20 °C	1.019	1.014	1.009	1.005	1.00
25 °C	1.026	1.019	1.013	1.006	1.00
30 °C	1.035	1.026	1.017	1.009	1.00
35 °C	1.047	1.035	1.023	1.012	1.00
40 °C	1.063	1.047	1.031	1.016	1.00

*Deviations when carrying out an air calibration without accessories,
O₂-saturation= display value*corr. factor*

Air calibration for highly accurate measurements ('Cal Air')

The electrode is exposed to **air with a relative atmospheric humidity of 100%**.

Proceed as follows: Put some distilled water in a bottle. Close bottle and generate a water steam saturation (100% rel. atmospheric humidity) in the remaining air by shaking it vigorously for approx. 3 minutes. Both water and air temperatures should be identical. Open bottle and insert electrode so that the diaphragm is in the air chamber.

Attention: By no means must the diaphragm get wet or be immersed in water. The bottle neck opening should only be slightly larger than the electrode diameter; make sure to avoid over pressure in the container.

Note: A correctly calibrated electrode shows 106 - 108% at air and at room temperature.

Calibration in air saturated water (configuration: 'Cal AqUA')

This mode of calibration is more difficult than the ones already described. As water is easily oversaturated it quickly results in calibration errors. In order to generate air saturated water, pure water (25-30°C) is poured into another container from a height of 50 cm. This process is repeated 20 times. In order to let an oversaturation evaporate, wait approx. 5 min. before carrying out the calibration (do not forget to stir).

Start calibration: press -key for 2 seconds

The display will show 'R. r Pt. 10' and as soon the values for oxygen and temperature are stable, the calibration will be finished.

Then the electrode state resulting of the successful calibration will be shown for a short time (evaluation in 10% steps: xx% ELEL.).

8.2 2 / 3-Point Calibration ('CAL 2-Pt, CAL 3-Pt')

The sensor will be automatically calibrated to the oxygen content of the atmosphere (20.95%) and one or two additional concentrations.

The calibration can be performed in gases (CAL Air: Air, 100% Oxygen and/ or 0% oxygen like nitrogen) or in saturated water solutions (CAL AQUA). The water solutions therefore have to be "gased" sufficiently with the referring gases. Another alternative for 0% is a Sodium sulfite solution (can also be used at CAL Air)

1. **Start calibration: press -key for 2 seconds**
2. **First calibration reference: (Pt.1)**

As first reference at a 3-point calibration, the zero reference has to be applied (NULL), at a 2-point calibration either 100% or 0%(NULL).

The display will show Pt. 1, and the referring reference which should be applied:

- NULL for 0% oxygen
- 0.2 for pure oxygen or oxygen saturated water

As long as the display blinks, no valid reference is recognised by the instrument.

As soon the values for oxygen and temperature are stable, the calibration of the first point will be finished.

The instrument tells you to apply the next reference (possible references are blinking in the display).

3. **Second calibration reference: (Pt.2)**

The display will show Pt. 2, and the referring reference which should be applied:

- Air for ambient air or AQUA for air saturated water
- 0.2 for pure oxygen or oxygen saturated water
- NULL for 0% oxygen

As long as the display blinks, no valid reference is recognised by the instrument.

As soon the values for oxygen and temperature are stable, the calibration of the second point will be finished. At 2-point calibration the calibration will be finished and the electrode state resulting of the

successful calibration will be shown for a short time (evaluation in 10% steps: xx% ELEC).

At 3-point calibration the instrument tells you to apply the next reference (possible reference is blinking)

4. **Third calibration reference: (Pt.3)**

The display will show Pt. 3, and the referring reference which should be applied:

As soon the values for oxygen and temperature are stable, the calibration of the second point will be finished. At 2-point calibration the calibration will be finished and the sensor state resulting of the successful calibration will be shown for a short time (evaluation in 10% steps: xx% ELEC).



In case of error messages being displayed during the calibration process, please refer to our notes at the end of this manual! If a calibration cannot be carried out after an extended period of time, at least one of the measuring values is unstable (oxygen partial pressure, temperature).

Please check your measuring arrangements!

8.3 Evaluation of Sensor State (ELEC)

Watch sensor state: press key "CAL" shortly once display show for a short time xx% ELEC.

It will show the electrode state resulting of the last successful calibration carried out.

The valuation is displayed in 10 percent steps: 100% means optimal sensor condition. Lower values are indicating that the sensor life time will be reached soon.

Remark: But also a erroneous pressure may be the cause of low valuation values.

9 Operation of the Logger

The device supports two different logger functions:

- „Func-Stor“: each time when „store“ (key 6) is pressed a measurement will be recorded.
- „Func-CYCL“: measurements will automatically be recorded at each interval, which was set in the logger menu ‚CYCL‘ until the logger will be stopped or the logger memory is full.
The recording is started by pressing „Store“ 2 seconds.

For the evaluation of the data the software GSOFT3050 (V3.5 or higher) has to be used. The software also allows easy configuration and starting of the logger.

When the logger is activated (Func Stor or Func CYCL) the hold and auto hold functions are no longer available, key 6 is solely used for the operation of the logger functions.

9.1 „Func-Stor“: Storing Single Measurement Sets

Each time when „store“ (key 6) is pressed a measurement and its time stamp will be recorded. The recorded data can be viewed either in the display (when calling the configuration an additional menu ‚REAd LoGG“ is displayed, see below) or by means of the interface and a PC with GSOFT3050-software.

The logger stores the current measuring, independent from the stability of the value.

- Max. number of data sets: 1000
- A data set contains:
- oxygen concentration in mg/l or ppm
 - oxygen saturation in percent or partial pressure in hPa or mmHg
 - temperature value at the time of recording in °C or °F
 - absolute pressure in hPa or mmHg or depth in m
 - time and date of the recording

After each recording „St. XX“ will be displayed for a short time. XX represents the number of the recording.

Input of the measuring point „L-Id“: Selection of measuring point via keys ▲ or ▼.

Number 0...19999 or text assigned to number 1...40

(Comfortable assignment of texts can be done with gratis software GMHKonfig)

Confirm input with „store“.

When logger memory contains recordings already:

When „Store“ is pressed for 2 seconds, the choice for clearing the logger memory will be displayed:



Clear all recordings



Clear the last recording



Clear nothing (cancel menu)

The selection can be made by ▲ (key 2) and ▼ (key 5). "Quit" (key 6) enters the choice.

If the logger memory is full, the display will show:



Viewing Recorded Data

Within the „LoGG Stor“ function the logger data can be viewed directly in the display not only by means of a computer (like at „Func CYCL“): press 2 seconds „Set“ (key 4): The first menu displayed now is „rEAd LoGG“ (read logger data). After pressing ▶ (key 3) the measurement recorded last will be displayed, changing between the different data referring to the measurement also is done by pressing ▶.

Changing the measurement is done by pressing the keys ▲ or ▼.

9.2 „Func-CYCL“: Automatic Recording With Selectable Logger-Cycle-Time

The Logger-Cycle-Time is selectable (p.r.t. Configuration). For example „CYCL“ = 1:00: A measuring is recorded after each 60 seconds.

Max. number of data sets:	8000
Cycle time:	0:01...60:00 (minutes:seconds, min 1s, max 1h), selectable in the configuration
A data set contains:	<ul style="list-style-type: none"> - oxygen concentration in mg/l or ppm - oxygen saturation in percent or partial pressure in hPa or mmHg - temperature value at the time of recording in °C or °F - absolute pressure in hPa or mmHg or depth in m
Recording time:	<ul style="list-style-type: none"> > 20 days with fresh battery (with output activated: OUT = SEr) With mains adapter: limited just by memory and cycle time, up to 333 days

Starting a recording:

By pressing "Store" (key 6) for 2 seconds the recording will be initiated. After that the display shows 'St.XXXX' for a short time whenever a measuring is recorded. XXXXX is the number of the measuring 1..9999.

If the logger memory is full, the display will show:  The recording automatically will be stopped.

Stopping the recording manually:

By pressing "Store" (key 6) the recording can be stopped manually. Then the following choice appears:



Stop the recording



Do not stop the recording

The selection can be made by ▲ (key 2) and ▼ (key 5). "Quit" (key 6) enters the choice.



If you try to switch off the instrument in the cyclic recording operation You will be asked once again if the recording should be stopped.

***The device can only be switched off after the recording has been stopped!
The Auto-Power-Off-function is deactivated during recording!***

Clear Recordings:

When "Store" is pressed for 2 seconds, the choice for clearing the logger memory will be displayed:



Clear all recordings

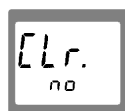

Clear nothing (cancel menu)

The selection can be made by ▲ (key 2) and ▼ (key 5). "Quit" (key 6) enters the choice.

10 Inspection of the accuracy / Adjustment Services

The instrument can be sent to the manufacturer for adjustment and function test.

Only the manufacturer can check all systems on correct them if necessary.

Calibration certificates – DKD-certificates – other certificates:

If device should be certificated for its accuracy, this is not possible for dissolved oxygen measuring, only for abs. Pressure and temperature.

11 Output

The output can be used as serial interface (for GRS3100 or GRS3105 interface adapters) or as analogue output (0-1V). If none of both is needed, we suggest to switch the output off, battery life then is extended.

11.1 Interface - Base Address ('Adr.')

By using an electrically isolated interface converter USB3100, GRS3100 or GRS3105 (accessory) the device can be connected to a PC.

With the GRS3105 it is possible to connect up to 5 instruments of the GMH3000 family to a single interface (please also refer to GRS3105-manual). As a precondition the base addresses of all devices must not be identical, make sure to configure the base addresses accordingly (refer menu point "Adr." in chapter 5). In order to avoid transmission errors, there are several security checks implemented (e.g. CRC).

The following standard software packages are available for data transfer:

- **GSOFT3050:** Operating and evaluation software for instruments with integrated logger function
- **EBS20M/ -60M:** 20- / 60-channel software to record and display the measuring values
- **GMHKonfig:** Software for a comfortable configuration of the device (e.g. freeware)

In case you want to develop your own software we offer a **GMH3000-development package** including

- an universally applicable 32bit Windows functions library ('GMH3000.DLL') with documentation that can be used by all 'serious' programming languages.
- Programming examples for Visual Studio 2010 (C#, C++), Visual Basic 6.0™, Delphi 1.0™, Testpoint™, Labview™

The Device has 4 Channels:

- oxygen concentration in mg/l or ppm
- oxygen saturation in percent or partial pressure in hPa or mmHg
- temperature value at the time of recording in °C or °F
- absolute pressure in hPa abs or mmHg abs or depth in m

Supported Interface-functions:

1	2	3	4	Code	Name/Function	1	2	3	4	Code	Name/Function
x	x	x	x	0	read nominal value	x	x	x	x	199	read measuring type in display
x	x	x	x	3	read system status	x	x	x	x	200	read min. display range
x				12	read ID-no.	x	x	x	x	201	read max. display range
x	x	x		22	read min alarm limit	x	x	x	x	202	read unit of display
x	x	x		23	read max alarm limit	x	x	x	x	204	read decimal point of display
x	x	x	x	176	read min measuring range	x				208	read channel count
x	x	x	x	177	read max measuring range	x				222	read turn-off-delay
x	x	x	x	178	read measuring range unit	x				223	Set turn-off-delay
x	x	x	x	179	read measuring range decimal point	x				240	Reset
x	x	x	x	180	read measuring type	x				254	read program identification



The measuring and range values read via interface are always in the selected display unit!

11.2 Analogue Output – Scaling with DAC.0 and DAC.1

With the DAC.0 and DAC.1 values the output can be rapidly scaled to Your efforts.

Keep in mind not to connect low-resistive loads to the output, otherwise the output value will be wrong and battery life is decreased. Loads above ca 10kOhm are uncritical.

If the display exceeds the value set by DAC.1, then the device will apply 1V to the output

If the display falls below the value set by DAC.0, then the device will apply 0V to the output

In case of an error (Err.1, Err.2, no sensor, etc.) the device will apply slightly above 1V to the output.

Plug wiring:

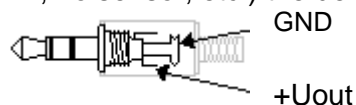

The 3rd contact has to be left floating!
Only stereo plugs are allowed!

12 GLP

GLP (Good Laboratory Practice) includes regular check of devices and accessories. For oxygen measurements it is highly important to ensure correct pH calibration. The device provides the following functions to help with this.

The usage of the GLP functions is only reasonable if the sensor is not changed. Although all data is stored in the device, it refers to the particular sensor.

12.1 Calibration interval (CAL) *(CAL)*

You can enter the interval after which the device reminds you to recalibrate in the configuration.

The interval times should be chosen according to the application and the stability of the sensor.

“CAL” flashes on the display as soon as the interval has expired.

12.2 Calibration storage (rEAd CAL)

The last calibrations are stored with results and date and can be read out.

Display calibration data:

Historical calibration data can be comfortably read out via PC software GMHKonfig and GSOFT3050 or displayed directly at the device:



Press for 2 seconds

The display will show:

or

(configuration level)



Press several times until this is displayed:

read cal. = “read calibration data”

Press shortly: switch between



- ELE = total electrode state evaluation in %
- SL.1 = Slope at 0% ... Air saturated water *1)
- SL.2 = Slope at air saturated water ... 100% *1)
- Date + time display of data set



or



Change between the different calibration data sets



Abort calibration storage display

*1 at 1 and 2-point calibration is $SL.1 = SL.2$

at 3-point calibration there are different slopes for the referring range segments.

13 Alarm („AL.“)

There are three possible settings:

Alarm off (AL. oFF), on with buzzer (AL. on), on without buzzer (AL. no.So).

Following conditions will display an alarm, when the function is activated (on or no.So):

- Value is below lower (AL. Lo) or above upper alarm rail (AL.Hi).
- Sensor error
- Low battery (bAt)
- Err.7: System error (always with buzzer)





In case of an alarm and when polling the interface the “prio”-flag is set in the returned message.

14 Real Time Clock („CLOC“)

The real time clock is used for the logger and GLP functions: Recorded values are also containing the point of time, when they were measured. Please check the settings when necessary.

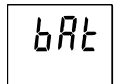
If the battery was replaced the referring menu ‚CLOC‘ will automatically be started

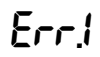
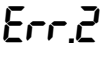







15 Error and System Messages

Display	Meaning	Remedy
	low battery voltage, device will continue to work for a short time	replace battery
	If mains operation: wrong voltage	replace power supply, if fault continues to exist: device damaged
	low battery voltage	replace battery
	If mains operation: wrong voltage	Check/replace power supply, if fault continues to exist: device damaged
No display or weird display Device does not react on keys	low battery voltage	replace battery
	If mains operation: wrong voltage	check/replace power supply, if fault continues to exist: device damaged
	system error	disconnect battery or power supply, wait some time, re-connect
	device defective	return to manufacturer for repair
	sensor error: no sensor cable connected	connect suitable sensor
	Sensor, cable or instrument defect	return to manufacturer for repair
	Value exceeding measuring range	Check: Is the value exceeding the measuring range specified? ->value too high!
	Wrong sensor connected	Check sensor
	Sensor, cable or instrument defect	return to manufacturer for repair
	Value below display range	Check: Is the value below the measuring range specified? ->value too low!
	Wrong sensor connected	Check sensor
	Sensor, cable or instrument defect	return to manufacturer for repair
	system error	return to manufacturer for repair

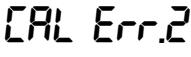
If “**bat**” is flashing, the battery will be exhausted soon. Further measurements are possible for short time.

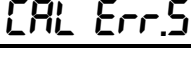
If “**bat**” is displayed continuously the battery is ultimately exhausted and has to be replaced. Further measurements aren't possible any more.

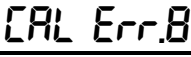
Messages During Calibration/Adjustment

	either preset calibration interval has expired or last calibration is not valid	Device has to be calibrated!
	wrong reference point at air	check sensor and reference gas / solution
	slope too low	
	reference gas / solution wrong sensor is defect	check sensor and reference gas / solution replace sensor / perform maintenance
	slope too high	
	reference gas / solution wrong sensor is defect	check sensor and reference gas / solution replace sensor / perform maintenance
	incorrect calibration temperature	calibration can only be done at 0...40 °C
	Zero value to low/negative	
	sensor is defect	replace sensor / perform maintenance
	zero value to high	
	reference gas / solution wrong sensor is defect	check sensor and reference gas / solution replace sensor / perform maintenance
	incorrect calibration pressure	check calibration pressure
	signal not stable / timeout	check sensor and reference gas / solution
	sensor not known: cannot be calibrated	check sensor and wiring

16 Specification

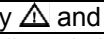
Measuring ranges	Oxygen concentration	0.00 ... 70.00 mg/l or ppm	electrochemical sensor GWO 3600
	Oxygen saturation	0.0 ... 600.0 % O ₂	
	Oxygen partial pressure	0 ... 1200 hPa O ₂ (0.0 .. 427.5 mmHg) [“]	
	Sensor temperature	-5.0 ... + 50.0 °C	NTC 10k (integrated in GWO 3600)
	Absolute pressure	300 ... 5000 hPa abs.**) 0 ... 40.0 m water column*)	integrated pressure sensor with pressure port
Accuracy at 25°C, 1000 hPa abs	Oxygen	±1.5 % of measured value ±0,2 mg/l (0-25 mg/l) or ±2.5 % of measured value±0,3 mg/l (25-70 mg/l)	
	Sensor temperature	± 0.1 °C	
Accuracy	Absolute pressure	3 hPa or 0.1% of measured value (the higher one to be applied)	
Working conditions		20 ... 50 °C; 0 ... 95 % r.H. (not condensing)	
Nom. temperature		25°C	
Storage temp.		-20 ... 70 °C	
Connections	O ₂ & temperature	6 pole Mini-DIN Socket	
	Absolute pressure	Universal pressure port for tubes with 4 or 6mm inner-Ø	
	Interface / Analogue output	serial, (3.5mm audio plug), via isolated adapter GRS3100, GRS3105 or USB3100 (accessories) for PC-USB or RS232- connection, alternatively selectable: Analogue output 0-1V	
	external supply	d.c. connector (diameter of internal pin 1.9 mm) for external 10.5-12V direct voltage supply. (suitable power supply: GNG10/3000)	
	Oxygen sensor GWO 3600	Working conditions	0 ... 40 °C
	Operating pressure	max. 3 bar	
Display		4 digit 7-segment 2 lines, additional segments	
Calibration	automatic	1 -, 2- or 3-point calibration, 0%, 100% or ambient air (20.95%) or air saturated water	
GLP		calibration storage adjustable calibration intervals (1 to 365 days, CAL warning after expiration)	
Data logger		Real-time clock Cyclic: 8000 data sets, cycle time 1s to 60 minutes Single: 1000 data sets, with measuring point input	
Alarm		Buzzer / visual / interface 2 channels: selectable oxygen unit and temperature	
Additional functions		Min / max / hold / auto hold	
Housing		Break-proof ABS housing	
	Protection class	Front side IP65	
	Dimensions L*B*H [mm]	Without pressure port: 142 x 71 x 26 mm (L x B x H)	
	Weight	approx. 170 g (incl. battery)	
Power supply		9V-Battery, Type IEC 6F22 (in scope of supply) or external supply	
Current consumption		Ca. 0.6 mA (if Out = Off ca. 0.4mA)	
Change battery indicator		Automatic at weak battery  and ' bAt '	
Auto-Off-Function		Device will be automatically switched off if no key is pressed/no interface communication takes place for the time of the power-off delay. The power-off delay can be set to values between 1 and 120 min.; it can be completely deactivated.	
EMI		The device corresponds to the essential protection ratings established in the Regulations of the Council for the Approximation of Legislation for the member countries regarding electromagnetic compatibility (2004/108/EG). Additional fault: <1%	

*) with accessories, please refer to chapter 7.2.2

**) please note: maximum pressure of GWO 3600 sensor is 3000hPa rel respectively 4000 hPa abs.

17 Reshipment and Disposal



Dispense exhausted batteries at destined gathering places.

This device must not be disposed as "residual waste". To dispose this device, please send it directly to us (adequately stamped). We will dispose it appropriately and environmentally friendly.



DANGER

All devices returned to the manufacturer have to be free of any residual of measuring media and other hazardous substances. Measuring residuals at housing or sensor may be a risk for persons or environment



Use an adequate transport package for reshipment, especially for fully functional devices. Please make sure that the device is protected in the package by enough packing materials.